













## The new **uniTec** product line

Weldon and shell mill holders for use with peripheral cooling or internal cooling

High-Precision reduction sleeves for Hydraulic tool holders

HSK holders			SK holders			BT holders			CAPTO holders	
HSK/ WD-CB	HSK/ MA-CB	HSK/ KBF	SK/ WD-CB	SK/ MA-CB	SK/ KBF	BT/ WD-CB	BT/ MA-CB	BT/ KBF	CAPTO/ WD	CAPTO/ MA
										
Page 6	Page 8	Page 9	Page 10	Page 12	Page 13	Page 14	Page 16	Page 17	Page 18	Page 21



# Toolholders

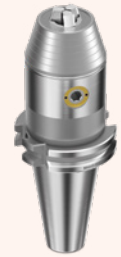

**WD-CB**

**MA-CB**

**WD**

**MA**

**KBF**

CoolBore	•	•	–	–	–
HSK	•	•	–	–	•
SK	•	•	–	–	•
BT	•	•	–	–	•
CAPTO	–	–	•	•	–
Balancing	Balanced by design	Balanced by design	Balanced by design	Balanced by design	Balanced by design
Diameter range	6–32	16–40	6–40	16–40	1–13

# uniTec Weldon holders and shell mill arbors with CB – CoolBore



## Features and benefits WD-CB

### Application

Ideally suited for use with tools without internal coolant supply and for machining workpieces with poor chip evacuation.

### Design

Two holes in the wall of the Weldon holder guide the coolant directly to the cutting edge of the tool.

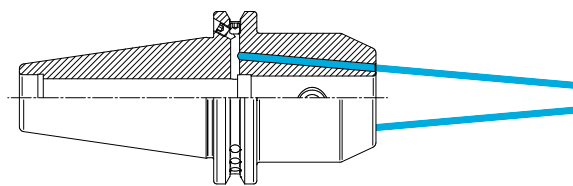

### Scope of delivery

With clamping screw and two M3 screw plugs to close the CoolBore holes if required (VS-CB).

### Accessories

The diameter of the CoolBore holes can be reduced with two reducing nozzles. This allows a higher coolant pressure to be achieved (RD-CB).

## Features and benefits MA-CB

### Application

For holding milling cutters with a cross groove, such as shell mill cutters. CoolBore allows the coolant to be fed through the tool directly to the cutting edge.

### Design

Four holes in the holder to guide the coolant into the milling arbor.

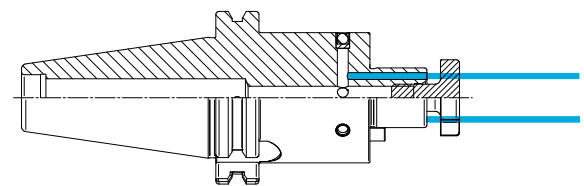

### Scope of delivery

With tensioning screw and permanently installed driving keys.

### Expert advice

For all HSK Weldon holders and shell mill arbors a range of coolant tubes (KSR) is available.

## Fitting the screw plug and reducing nozzle

Screw plugs or reducing nozzles can be screwed in through the threads in the CoolBore holes. The VS-CB and RD-CB are fitted using an Allen key.



**25 bar**



**40 bar**



If cooling through the tool shank is required, the screw plugs must be fitted. In addition, the outlet diameter of the CoolBore holes can be reduced to 0.5mm using reducing nozzles. This will increase the effect of the coolant jet.

uniTec CB

PG-CB

ER-CB



// Discover the CoolBore features also in powRgrip® and ER products.

# Weldon end mill holders HSK /WD-CB

Designed for rotating applications, all our HSK holders are suited for high-speed applications where a consistent performance is key.

DIN 69893/ISO 12164

## Features of end mill holders (Weldon)

### Runout TIR $\leq 3 \mu\text{m}$

Measured from inner bore to outer taper.

### Precision side locking screw

For highest transferable torque.

### ID chip hole (only HSK form A)

In accordance with DIN 69873 for 10 mm diameter.

Other HSK-forms available on request.



### Expert advice

For all HSK tool holders a range of coolant tubes (KSR) is available.

# Weldon end mill holders HSK-A/WD-CB

HSK/WD-CB

DIN 69893

ISO 12164

Type	Part no.	Dimensions [mm]		
		DCONWS	BD1	LPR
<b>HSK-A 40</b>				
HSK-A 40 / WD 6-CB x 060	5540.30630	6	25	60
HSK-A 40 / WD 8-CB x 060	5540.30830	8	28	60
HSK-A 40 / WD 10-CB x 060	5540.31030	10	35	60
HSK-A 40 / WD 12-CB x 070	5540.31240	12	42	70
HSK-A 40 / WD 16-CB x 075	5540.31640	16	48	75

<b>HSK-A 63</b>				
HSK-A 63 / WD 6-CB x 065	5563.30630	6	25	65
HSK-A 63 / WD 6-CB x 120	5563.30670	6	25	120
HSK-A 63 / WD 8-CB x 065	5563.30830	8	28	65
HSK-A 63 / WD 8-CB x 120	5563.30870	8	28	120
HSK-A 63 / WD 10-CB x 065	5563.31030	10	35	65
HSK-A 63 / WD 10-CB x 120	5563.31070	10	35	120
HSK-A 63 / WD 12-CB x 080	5563.31250	12	42	80
HSK-A 63 / WD 12-CB x 120	5563.31270	12	42	120
HSK-A 63 / WD 16-CB x 080	5563.31650	16	48	80
HSK-A 63 / WD 16-CB x 120	5563.31670	16	48	120
HSK-A 63 / WD 20-CB x 080	5563.32050	20	52	80
HSK-A 63 / WD 20-CB x 120	5563.32070	20	52	120
HSK-A 63 / WD 25-CB x 110	5563.32560	25	65	110
HSK-A 63 / WD 32-CB x 110	5563.33260	32	72	110

<b>HSK-A 100</b>				
HSK-A 100 / WD 12-CB x 080	5500.31250	12	42	80
HSK-A 100 / WD 16-CB x 100	5500.31660	16	48	100
HSK-A 100 / WD 20-CB x 100	5500.32060	20	52	100
HSK-A 100 / WD 25-CB x 100	5500.32560	25	65	100
HSK-A 100 / WD 32-CB x 100	5500.33260	32	72	100

Type	Part no.	Dimensions [mm]			
		D	L	SW	
<b>CoolBore nozzle</b>					
SET VS-CB M3*	7781.03000	M3	6	1.5	Screw plug for CoolBore drill hole
SET RD-CB M3   Ø 0.5 mm	7788.03050	M3	6	1.5	Reducing nozzle for CoolBore drill hole

\*Included in delivery with each holder (2 pcs.)

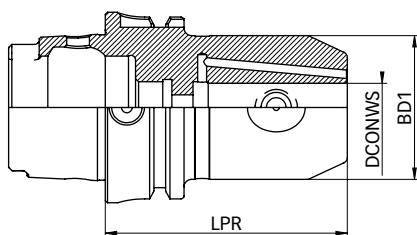

HSK-A/WD-CB

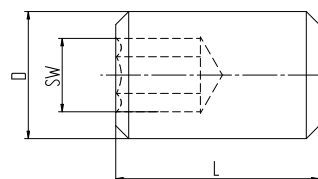

VS-CB M3

# Shell mill arbor HSK-A/MA-CB

**HSK/MA-CB**

**DIN 69893**

**ISO 12164**

Type	Part no.	Dimensions [mm]			Accessories
		DCONWS	BD1	LF	Wrench
<b>HSK-A 63</b>					
HSK-A 63 / MA 16-CB x 050	5563.01620	16	38	50	FDS 16
HSK-A 63 / MA 16-CB x 100	5563.01660	16	38	100	FDS 16
HSK-A 63 / MA 22-CB x 050	5563.02220	22	48	50	FDS 22
HSK-A 63 / MA 22-CB x 100	5563.02260	22	48	100	FDS 22
HSK-A 63 / MA 27-CB x 060	5563.02730	27	60	60	FDS 27
HSK-A 63 / MA 27-CB x 100	5563.02760	27	60	100	FDS 27
HSK-A 63 / MA 32-CB x 060	5563.03230	32	78	60	FDS 32
HSK-A 63 / MA 32-CB x 100	5563.03260	32	78	100	FDS 32
HSK-A 63 / MA 40-CB x 060	5563.04030	40	89	60	FDS 40
HSK-A 63 / MA 40-CB x 100	5563.04060	40	89	100	FDS 40

<b>HSK-A 100</b>					
HSK-A 100 / MA 16-CB x 050	5500.01620	16	38	50	FDS 16
HSK-A 100 / MA 22-CB x 050	5500.02220	22	48	50	FDS 22
HSK-A 100 / MA 27-CB x 050	5500.02720	27	60	50	FDS 27
HSK-A 100 / MA 32-CB x 050	5500.03220	32	78	50	FDS 32
HSK-A 100 / MA 40-CB x 060	5500.04030	40	89	60	FDS 40

Included in delivery: Shell mill arbor and lock screw

HSK-A: Hole for data carrier DIN STD 69873 in the flange available on request

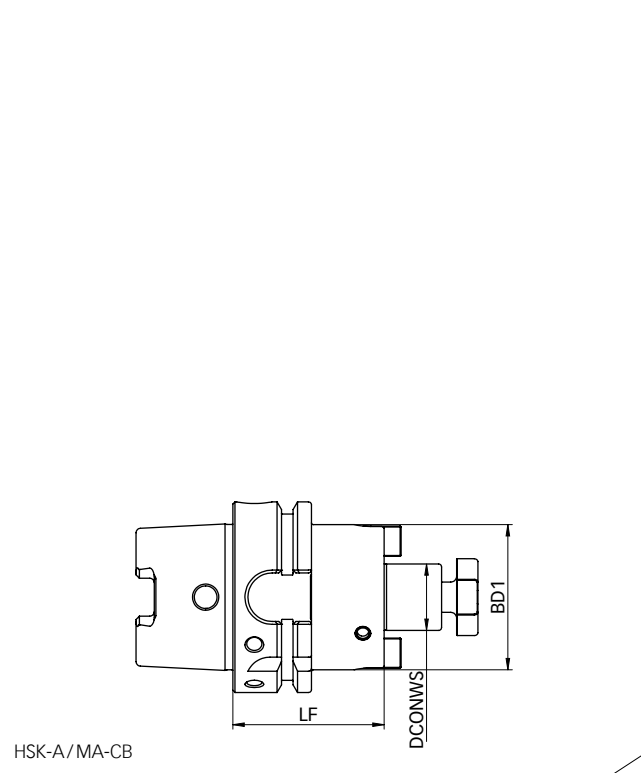

# Drill chucks HSK-A/KBF

**HSK-A/KBF**

DIN 69893

ISO 12164

Type	Part no.	Dimensions [mm]		
		DCONWS	BD1	LPR
<b>HSK-A 63/KBF</b>				
HSK-A 63/KBF 1.0 – 13.0 mm	2563.50100	1–13	50	104

HSK-A: Hole for data carrier DIN STD 69873 in the flange available on request

Drill chucks HSK-A/KBF

## Features and benefits

### Clamping range

1–13 mm

### Runout TIR

0.03 mm

### Maximum tightening torque

20 Nm

### Clamping force (at 20 Nm tightening torque)

80 Nm

### Maximum rpm

35 000 rpm



HSK-A/KBF

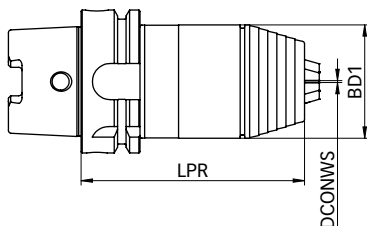

HSK-A/KBF

# Weldon end mill holders SK/WD-CB

Universally suitable for different machining applications

DIN 69871/DIN ISO 7388-1

## Features of end mill holders (Weldon)

### Runout TIR $\leq 3 \mu\text{m}$

Measured from inner bore to outer taper.

### Taper accuracy AT3

Better spindle-to-holder fit and accuracy.

### Precision side locking screw

For highest transferable torque.

### Coolant supply

All toolholders with form AD/AF can be used for cooling. Form AD/AF delivers the coolant supply through the taper or via the flange at the gripper groove.

### ID chip hole

In accordance with DIN 69873 for 10 mm diameter.



# Weldon end mill holders SK/WD-CB

**SK/WD-CB**

DIN 69871

DIN ISO 7388-1

Type	Part no.	Dimensions [mm]			Form AD/AF
		DCONWS	BD1	LPR	
<b>SK 40</b>					
SK 40 / WD 6-CB x 050	5240.30620	6	25	50	•
SK 40 / WD 6-CB x 100	5240.30660	6	25	100	•
SK 40 / WD 8-CB x 050	5240.30820	8	28	50	•
SK 40 / WD 8-CB x 100	5240.30860	8	28	100	•
SK 40 / WD 10-CB x 050	5240.31020	10	35	50	•
SK 40 / WD 10-CB x 100	5240.31060	10	35	100	•
SK 40 / WD 12-CB x 050	5240.31220	12	42	50	•
SK 40 / WD 12-CB x 100	5240.31260	12	42	100	•
SK 40 / WD 16-CB x 063	5240.31630	16	48	63	•
SK 40 / WD 16-CB x 100	5240.31660	16	48	100	•
SK 40 / WD 20-CB x 063	5240.32030	20	52	63	•
SK 40 / WD 20-CB x 100	5240.32060	20	52	100	•
SK 40 / WD 25-CB x 100	5240.32560	25	65	100	•
SK 40 / WD 32-CB x 100	5240.33260	32	72	100	•

<b>SK 50</b>					
SK 50 / WD 12-CB x 063	5250.31230	12	42	63	•
SK 50 / WD 16-CB x 063	5250.31630	16	48	63	•
SK 50 / WD 20-CB x 063	5250.32030	20	52	63	•
SK 50 / WD 25-CB x 080	5250.33250	25	65	80	•
SK 50 / WD 32-CB x 100	5250.33260	32	72	100	•

Type	Part no.	Dimensions [mm]			
		D	L	SW	
<b>CoolBore nozzle</b>					
SET VS-CB M3*	7781.03000	M3	6	1.5	Screw plug for CoolBore drill hole
SET RD-CB M3   Ø 0.5 mm	7788.03050	M3	6	1.5	Reducing nozzle for CoolBore drill hole

\*Included in delivery with each holder (2 pcs.)

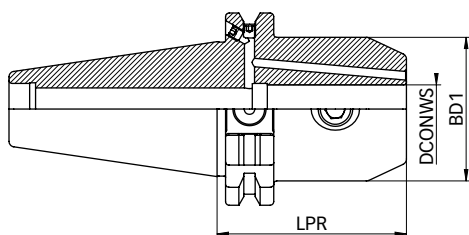

SK/WD-CB

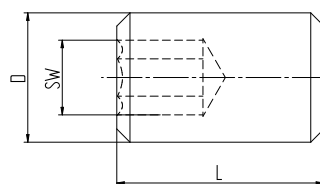

VS-CB M3

# Shell mill arbor SK/MA-CB

**SK/MA-CB**

DIN 69871

DIN ISO 7388-1

Type	Part no.	Dimensions [mm]			Form AD/AF	Accessories
		DCONWS	BD1	LF		Wrench
<b>SK 40</b>						
SK 40 / MA 16-CB x 060	5240.01630	16	38	60	•	FDS 16
SK 40 / MA 22-CB x 060	5240.02230	22	48	60	•	FDS 22
SK 40 / MA 27-CB x 060	5240.02730	27	50	60	•	FDS 27
SK 40 / MA 32-CB x 070	5240.03240	32	78	70	•	FDS 32
SK 40 / MA 40-CB x 070	5240.04040	40	89	70	•	FDS 40

Included in delivery: Shell mill arbor and lock screw

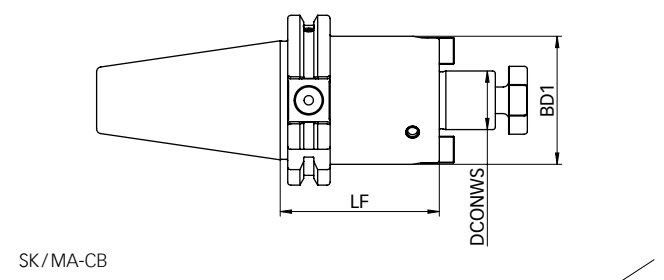

# Drill chucks SK /KBF

SK /KBF

DIN 69871

DIN ISO 7388-1

Type	Part no.	Dimensions [mm]				
		DCONWS	BD1	LPR	Form A	Form A+AD
<b>SK 30</b>						
SK 30/KBF 1.0 – 13.0 mm	2230.50100	1–13	50	111	•	–
<b>SK 40</b>						
SK 40/KBF 1.0 – 13.0 mm	2240.50103	1–13	50	90	–	•
<b>SK 50</b>						
SK 50/KBF 1.0 – 13.0 mm	2250.50103	1–13	50	106	–	•

Drill chucks SK /KBF

## Features and benefits

### Clamping range

1–13 mm

### Runout TIR

0.03 mm

### Maximum tightening torque

20 Nm

### Clamping force (at 20 Nm tightening torque)

80 Nm

### Maximum rpm

35 000 rpm



SK /KBF

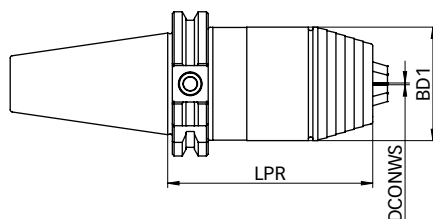

SK /KBF

# Weldon end mill holders BT /WD-CB

Universally suitable different machining applications, the BT interface toolholders cater to various machining needs.

MAS 403 / JIS B 6339 / DIN ISO 7388-2

## Features of end mill holders (Weldon)

### Runout TIR $\leq 3 \mu\text{m}$

Measured from inner bore to outer taper.

### Taper accuracy AT3

Better spindle-to-holder fit and accuracy.

### Precision side locking screw

For highest transferable torque.

### Coolant supply

All toolholders with form JD/JF can be used for cooling. Form JD/JF delivers the coolant supply through the taper or via the flange at the gripper groove.



# Weldon end mill holders BT/WD-CB

**BT/WD-CB**

MAS 403

JIS B 6339

DIN ISO 7388-2

Type	Part no.	Dimensions [mm]			Form JD/JF
		DCONWS	BD1	LPR	
<b>BT 30</b>					
BT 30 / WD 6-CB x 050	5130.30620	6	25	50	•
BT 30 / WD 8-CB x 050	5130.30820	8	28	50	•
BT 30 / WD 10-CB x 050	5130.31020	10	35	50	•
BT 30 / WD 12-CB x 052	5130.31220	12	42	52	•
BT 30 / WD 16-CB x 063	5130.31630	16	48	63	•
BT 30 / WD 20-CB x 063	5130.32030	20	52	63	•

<b>BT 40</b>					
BT 40 / WD 6-CB x 050	5140.30620	6	25	50	•
BT 40 / WD 8-CB x 050	5140.30820	8	28	50	•
BT 40 / WD 10-CB x 063	5140.31030	10	35	63	•
BT 40 / WD 12-CB x 063	5140.31230	12	42	63	•
BT 40 / WD 16-CB x 063	5140.31630	16	48	63	•
BT 40 / WD 20-CB x 063	5140.32030	20	52	63	•
BT 40 / WD 25-CB x 090	5140.32550	25	65	90	•
BT 40 / WD 32-CB x 100	5140.33260	32	72	100	•

<b>BT 50</b>					
BT 50 / WD 16-CB x 080	5150.31650	16	48	80	•
BT 50 / WD 20-CB x 080	5150.32050	20	52	80	•
BT 50 / WD 25-CB x 100	5150.32560	25	65	100	•
BT 50 / WD 32-CB x 105	5150.33260	32	72	105	•
BT 50 / WD 40-CB x 110	5150.34060	40	80	110	•

Type	Part no.	Dimensions [mm]			
		D	L	SW	
<b>CoolBore nozzle</b>					
SET VS-CB M3*	7781.03000	M3	6	1.5	Screw plug for CoolBore drill hole
SET RD-CB M3   Ø 0.5 mm	7788.03050	M3	6	1.5	Reducing nozzle for CoolBore drill hole

\*Included in delivery with each holder (2 pcs.)

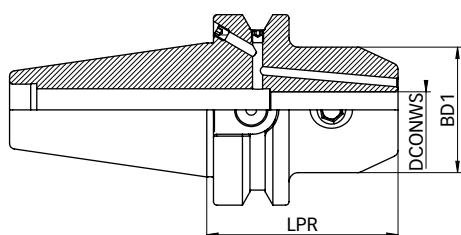

BT/WD-CB

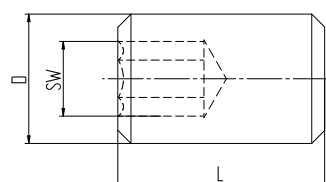

VS-CB M3

# Shell mill arbor BT/MA-CB

**BT/MA-CB**

MAS 403

JIS B 6339

DIN ISO 7388-2

Type	Part no.	Dimensions [mm]			Form JD/JF	Accessories
		DCONWS	BD1	LF		Wrench
<b>BT 30</b>						
BT 30 / MA 16-CB x 035	5130.01610	16	38	35	•	FDS 16
BT 30 / MA 22-CB x 035	5130.02210	22	48	35	•	FDS 22
BT 30 / MA 27-CB x 035	5130.02710	27	60	35	•	FDS 27
<b>BT 40</b>						
BT 40 / MA 16-CB x 035	5140.01610	16	38	35	•	FDS 16
BT 40 / MA 16-CB x 100	5140.01660	16	38	100	•	FDS 16
BT 40 / MA 22-CB x 035	5140.02210	22	48	35	•	FDS 22
BT 40 / MA 22-CB x 100	5140.02260	22	48	100	•	FDS 22
BT 40 / MA 27-CB x 035	5140.02710	27	60	35	•	FDS 27
BT 40 / MA 27-CB x 100	5140.02760	27	60	100	•	FDS 27
BT 40 / MA 32-CB x 050	5140.03220	32	78	50	•	FDS 32
BT 40 / MA 32-CB x 100	5140.03260	32	78	100	•	FDS 32
BT 40 / MA 40-CB x 050	5140.04020	40	89	50	•	FDS 40
<b>BT 50</b>						
BT 50 / MA 22-CB x 055	5150.02220	22	48	55	•	FDS 22
BT 50 / MA 27-CB x 055	5150.02720	27	60	55	•	FDS 27
BT 50 / MA 32-CB x 055	5150.03220	32	78	55	•	FDS 32
BT 50 / MA 40-CB x 055	5150.04020	40	89	55	•	FDS 40

Included in delivery: Shell mill arbor and lock screw

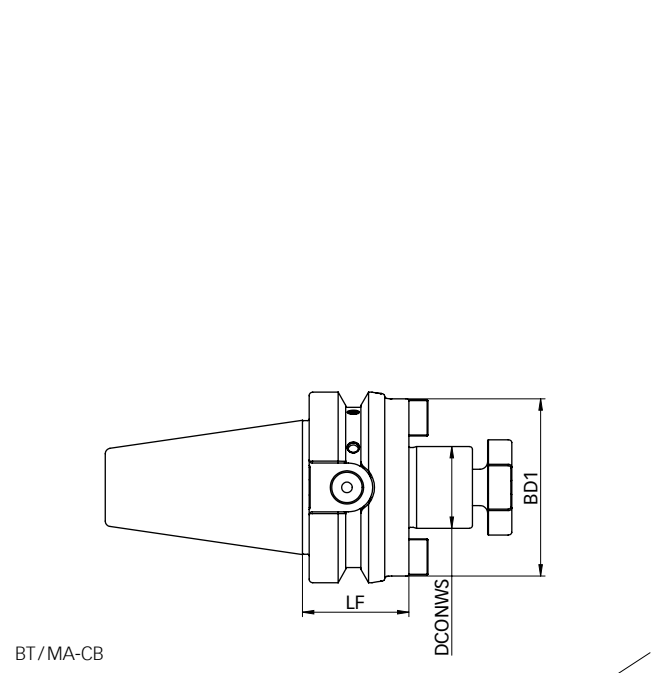

# Drill chucks BT /KBF

BT /KBF

MAS 403

JIS B 6339

DIN ISO 7388-2

Type	Part no.	Dimensions [mm]				
		DCONWS	BD1	LPR	Form A	Form A+AD
<b>BT 30</b>						
BT 30/KBF 1.0 – 13.0 mm	2130.50100	1–13	50	95	•	–
<b>BT 40</b>						
BT 40/KBF 1.0 – 13.0 mm	2140.50103	1–13	50	98	–	•
<b>BT 50</b>						
BT 50/KBF 1.0 – 13.0 mm	2150.50103	1–13	50	100	–	•

Drill chucks BT /KBF

## Features and benefits

### Clamping range

1–13 mm

### Runout TIR

0.03 mm

### Maximum tightening torque

20 Nm

### Clamping force (at 20 Nm tightening torque)

80 Nm

### Maximum rpm

35 000 rpm

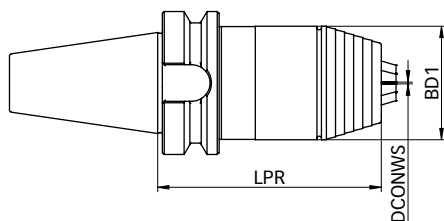

BT /KBF

# REGO-FIX CAPTO licensed by Sandvik Coromant Weldon end mill holders REGO-FIX C/WD

These self-centering and balanced holders enable a high torque transmission and show a high bending strength.

ISO 26623

## Features of end mill holders (Weldon)

### Runout TIR $\leq 3 \mu\text{m}$

Measured from inner bore to outer taper.

### Precision side locking screw

For highest transferable torque.

**Certified** REGO-FIX CAPTO – licensed by Sandvik Coromant – is manufactured at REGO-FIX Switzerland under license according to CAPTO specifications.



# REGO-FIX CAPTO holders licensed by Sandvik Coromant

## Weldon end mill holders REGO-FIX C/WD

C/WD

ISO 26623

Type	Part no.	Dimensions [mm]		
		DCONWS	BD1	LPR
<b>C3</b>				
C3/WD 6 x 045	2803.30610	6	25	45
C3/WD 8 x 045	2803.30810	8	28	45
C3/WD 10 x 050	2803.31020	10	35	50
C3/WD 12 x 055	2803.31220	12	42	55
<b>C4</b>				
C4/WD 6 x 050	2804.30620	6	25	50
C4/WD 8 x 050	2804.30820	8	28	50
C4/WD 10 x 050	2804.31020	10	35	50
C4/WD 12 x 055	2804.31220	12	42	55
C4/WD 14 x 055	2804.31420	14	44	55
C4/WD 16 x 055	2804.31620	16	48	55
<b>C5</b>				
C5/WD 6 x 050	2805.30620	6	25	50
C5/WD 8 x 050	2805.30820	8	28	50
C5/WD 10 x 055	2805.31020	10	35	55
C5/WD 12 x 060	2805.31230	12	42	60
C5/WD 14 x 060	2805.31430	14	44	60
C5/WD 16 x 060	2805.31630	16	48	60
C5/WD 18 x 060	2805.31830	18	50	60
C5/WD 20 x 060	2805.32030	20	52	60
C5/WD 25 x 080	2805.32550	25	65	80

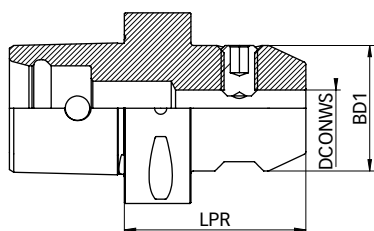

C/WD

# REGO-FIX CAPTO holders licensed by Sandvik Coromant

## Weldon end mill holders REGO-FIX C/WD

**C/WD**  
ISO 26623

Type	Part no.	Dimensions [mm]		
		DCONWS	BD1	LPR
<b>C6</b>				
C6/WD 6 x 055	2806.30620	6	25	55
C6/WD 8 x 055	2806.30820	8	28	55
C6/WD 10 x 060	2806.31030	10	35	60
C6/WD 12 x 060	2806.31230	12	42	60
C6/WD 14 x 060	2806.31430	14	44	60
C6/WD 16 x 065	2806.31630	16	48	65
C6/WD 18 x 065	2806.31830	18	50	65
C6/WD 20 x 065	2806.32030	20	52	65
C6/WD 25 x 080	2806.32550	25	65	80
C6/WD 32 x 090	2806.33250	32	72	90
C6/WD 40 x 100	2806.34060	40	80	100

<b>C8</b>				
C8/WD 6 x 070	2808.30640	6	25	70
C8/WD 8 x 070	2808.30840	8	28	70
C8/WD 10 x 070	2808.31040	10	35	70
C8/WD 12 x 070	2808.31240	12	42	70
C8/WD 14 x 070	2808.31440	14	44	70
C8/WD 16 x 070	2808.31640	16	48	70
C8/WD 18 x 070	2808.31840	18	50	70
C8/WD 20 x 070	2808.32040	20	52	70
C8/WD 25 x 080	2808.32550	25	65	80
C8/WD 32 x 080	2808.33250	32	72	80
C8/WD 40 x 110	2808.34060	40	80	110

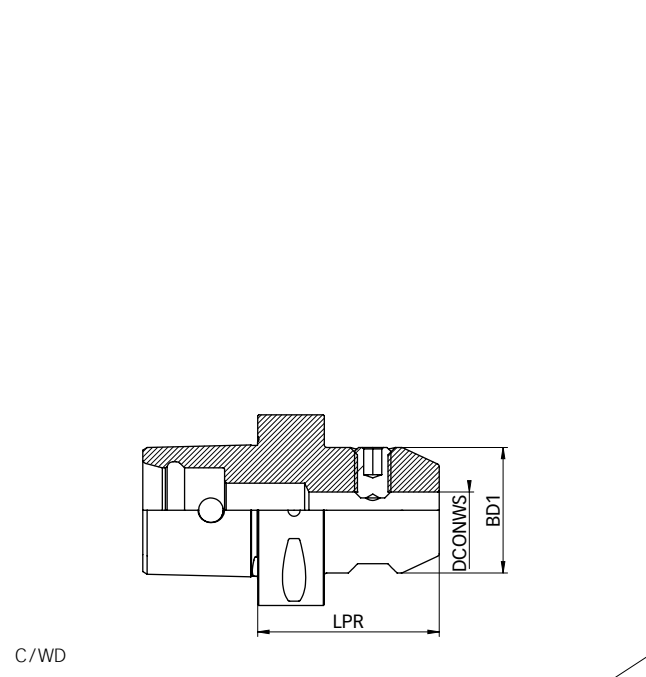

# REGO-FIX CAPTO holders licensed by Sandvik Coromant

## Shell mill arbor REGO-FIX C/MA

C/MA

ISO 26623

Type	Part no.	Dimensions [mm]		
		DCONWS	BD1	LF
<b>C3</b>				
C3/MA 16 x 030	2803.01610	16	36	30
<b>C4</b>				
C4/MA 16 x 032	2804.01610	16	36	32
C4/MA 16 x 055	2804.01620	16	36	55
C4/MA 22 x 025	2804.02210	22	48	25
C4/MA 22 x 055	2804.02220	22	48	55
<b>C5</b>				
C5/MA 16 x 035	2805.01610	16	36	35
C5/MA 16 x 070	2805.01640	16	36	70
C5/MA 22 x 025	2805.02210	22	50	25
C5/MA 22 x 070	2805.02240	22	48	70
C5/MA 27 x 025	2805.02710	27	56	25
C5/MA 32 x 040	2805.03210	32	65	40

Included in delivery: Shell mill arbor and lock screw



C/MA

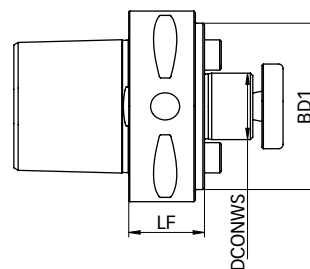

C/MA

# REGO-FIX CAPTO holders licensed by Sandvik Coromant

## Shell mill arbor REGO-FIX C/MA

C/MA

ISO 26623

Type	Part no.	Dimensions [mm]		
		DCONWS	BD1	LF
<b>C6</b>				
C6/MA 16 x 040	2806.01610	16	36	40
C6/MA 22 x 025	2806.02210	22	55	25
C6/MA 27 x 025	2806.02710	27	63	25
C6/MA 32 x 025	2806.03210	32	65	25
C6/MA 40 x 040	2806.04010	40	80	40
<b>C8</b>				
C8/MA 16 x 050	2808.01620	16	36	50
C8/MA 22 x 030	2808.02210	22	55	30
C8/MA 27 x 030	2808.02710	27	65	30
C8/MA 32 x 030	2808.03210	32	80	30
C8/MA 40 x 030	2808.04010	40	80	30

Included in delivery: Shell mill arbor and lock screw

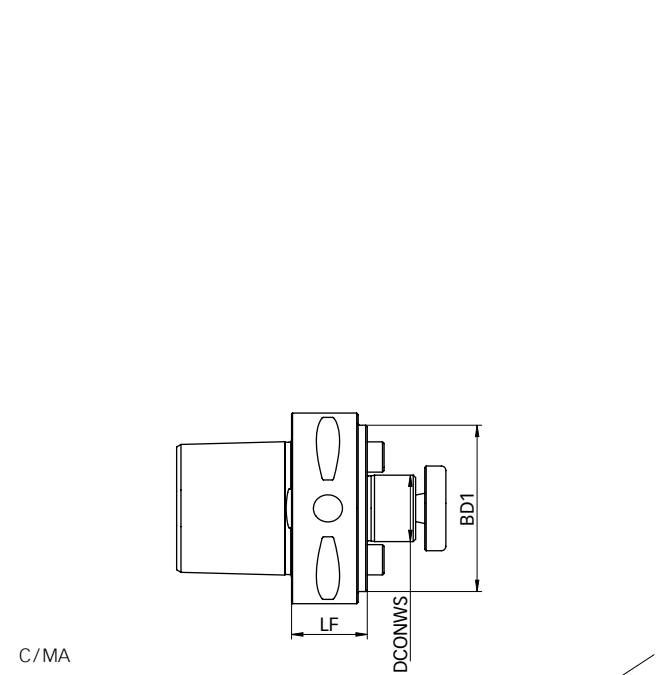



## Reduction sleeves for hydraulic chucks

Outstanding runout accuracy and highest clamping force for peripheral or internal cooling applications

---

**Reduction sleeves  
for hydro chucks**

HS

HS-CF  
with coolant flush

HS-MB  
Micro-Bore

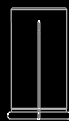
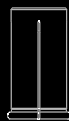

Page 25

Page 25

Page 25



# Reduction sleeves for hydro chucks

Reduction sleeves are designed to fit hydro chucks of different manufacturers. They are specially suited for high-precision clamping of cylindrical tool shanks.

**Reduction sleeves for hydro chucks** Our reduction sleeves are designed to fit hydro chucks of different manufacturers. They are specially suited for high-precision clamping of cylindrical tool shanks per DIN 6535 form HA, HB and HE, as well as tool shanks per DIN 1835 form B, C, D and E.

The special design of REGO-FIX reduction sleeves allows an efficient use of coolant through cutting tools. This self-sealing system works with the most common hydraulic expansion chucks.

- Correct assembly** Improper assembly can damage the concentricity of the reduction sleeve.
- // Insert tools the full length of the reduction sleeve
  - // Only clamp h6 tool shanks
  - // Do not clamp reduction sleeve without a tool, as this could result in a damaged reduction sleeve

## Concentricity (TIR) of REGO-FIX HS type reduction sleeves

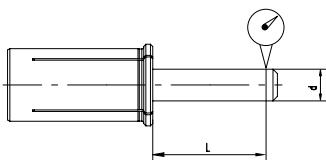

Clamping diameter d [mm]			max. TIR [mm]
> d	≤d	L	
3,0	6,0	16	0,003
6,0	10,0	25	0,003
10,0	18,0	40	0,003
18,0	26,0	50	0,003



**Swiss quality standard**  
Our products marked Swiss made are manufactured at our headquarters in Tenniken, Switzerland.

## Reductions sleeves for hydro chucks HS

### Features and benefits

#### Accurate precision

Runout TIR < 3 μm

#### High flexibility

Clamp different tool shank diameters in hydro chucks: 6, 8, 12, 16, 20, 25 and 32 mm.

#### Standard version HS suited for internal cooling

Metal-to-metal seal for cutting tools with internal coolant channels.

#### HS-CF suited for peripheral cooling

The coolant flush reductions sleeves HS-CF can be used for peripheral cooling due to their coolant channels.

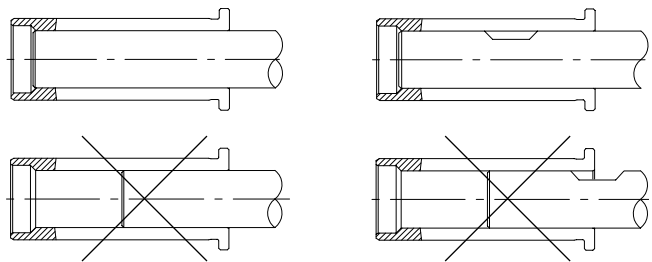



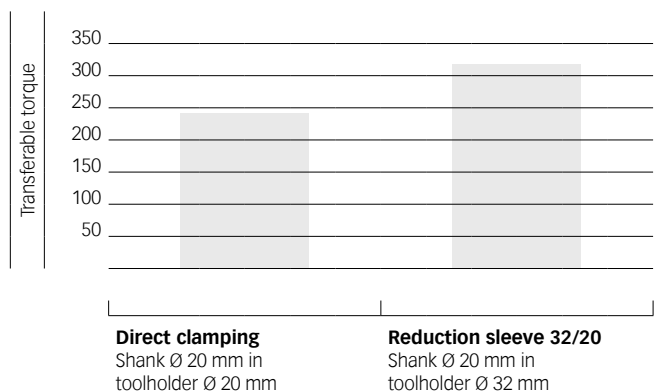







## Comparison of transferable torque at Ø 20 mm







# Reduction sleeves HS, HS-CF and HS-MB

A wide standard range of high-precision reduction sleeves: cutting tools with shanks from 1.0 mm to 25 mm can be reliably and securely clamped in any hydraulic chuck.

## Metric

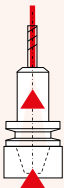
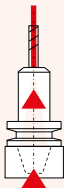
	HS 6	HS 8	HS 12-MB	HS 12	HS 12-CF	HS 16	HS 20	HS 20-CF	HS 25	HS 32	HS 32-CF
Outer diameter	Ø 6	Ø 8	Ø 12	Ø 12	Ø 12	Ø 16	Ø 20	Ø 20	Ø 25	Ø 32	Ø 32
Shank diameter	1–4 mm	6 mm	1–2.5 mm	3–10 mm	3–8 mm	3–12 mm	3–18 mm	3–16 mm	3–20 mm	3–25 mm	6–25 mm
Shank tolerance [mm]	All reduction sleeves are designed for tools with shank tolerance h6 or more accurate										
For internal coolant	•	•		•		•	•		•	•	
For peripheral coolant			•		•			•			•
Technical illustrations of cooling											
Safety note	Never clamp reduction sleeves without a tool, it can be permanently damaged										

## Inch

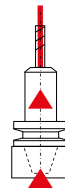
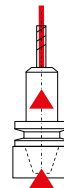
	HS 12	HS 20	HS 25	HS 32	HS 1/2"	HS 3/4"	HS 1"	HS 1 1/4"
Outer diameter	Ø 12 mm	Ø 20 mm	Ø 25 mm	Ø 32 mm	Ø 1/2"	Ø 3/4"	Ø 1"	Ø 1 1/4"
Shank diameter	1/8–3/8"	1/8–5/8"	1/8–13/16"	3/16–1"	1/8–3/8"	1/8–5/8"	1/8–3/4"	3/16–1"
Shank tolerance [mm]	All reduction sleeves are designed for tools with shank tolerance h6 or more accurate							
For internal coolant	•	•	•	•	•	•	•	•
Technical illustrations of cooling								
Safety note	Never clamp reduction sleeves without a tool, it can be permanently damaged							

# Reduction sleeves HS and HS-CF [metric]

HS

Ø bore	Part no.										
[mm]	HS 6	HS 8	HS 12-MB	HS 12	HS 12-CF	HS 16	HS 20	HS 20-CF	HS 25	HS 32	HS 32-CF
1,0	1906.01000	-	1912.01009*	-	-	-	-	-	-	-	-
1,5	-	-	1912.01509*	-	-	-	-	-	-	-	-
2,0	1906.02000	-	1912.02009*	-	-	-	-	-	-	-	-
2,5	-	-	1912.02509*	-	-	-	-	-	-	-	-
3,0	1906.03000	-	-	1912.03000	1912.03002	1916.03000	1920.03000	1920.03002	1925.03000	1932.03000	-
4,0	1906.04000	-	-	1912.04000	1912.04002	1916.04000	1920.04000	1920.04002	1925.04000	1932.04000	-
5,0	-	-	-	1912.05000	1912.05002	-	1920.05000	1920.05002	1925.05000	1932.05000	-
6,0	-	1908.06000	-	1912.06000	1912.06002	1916.06000	1920.06000	1920.06002	1925.06000	1932.06000	1932.06002
7,0	-	-	-	1912.07000	-	-	1920.07000	-	1925.07000	1932.07000	-
8,0	-	-	-	1912.08000	1912.08002	1916.08000	1920.08000	1920.08002	1925.08000	1932.08000	1932.08002
9,0	-	-	-	1912.09000	-	-	1920.09000	-	1925.09000	1932.09000	-
10,0	-	-	-	1912.10000	-	1916.10000	1920.10000	1920.10002	1925.10000	1932.10000	1932.10002
11,0	-	-	-	-	-	-	1920.11000	-	-	1932.11000	-
12,0	-	-	-	-	-	1916.12000	1920.12000	1920.12002	1925.12000	1932.12000	1932.12002
13,0	-	-	-	-	-	-	1920.13000	-	-	1932.13000	-
14,0	-	-	-	-	-	-	1920.14000	1920.14002	1925.14000	1932.14000	1932.14002
15,0	-	-	-	-	-	-	1920.15000	-	-	1932.15000	-
16,0	-	-	-	-	-	-	1920.16000	1920.16002	1925.16000	1932.16000	1932.16002
17,0	-	-	-	-	-	-	-	-	-	1932.17000	-
18,0	-	-	-	-	-	-	1920.18000	-	1925.18000	1932.18000	1932.18002
19,0	-	-	-	-	-	-	-	-	-	1932.19000	-
20,0	-	-	-	-	-	-	-	-	1925.20000	1932.20000	1932.20002
21,0	-	-	-	-	-	-	-	-	-	-	-
22,0	-	-	-	-	-	-	-	-	-	1932.22000	-
23,0	-	-	-	-	-	-	-	-	-	-	-
24,0	-	-	-	-	-	-	-	-	-	-	-
25,0	-	-	-	-	-	-	-	-	-	1932.25000	1932.25002

\*not metallic sealing



# Reduction sleeves HS [inch]

HS

Ø bore		Part no.			
[decimal inch]	[inch]	HS 12	HS 20	HS 25	HS 32
0,125	1/8"	1912.03181	1920.03181	1925.03181	–
0,1875	3/16"	1912.04761	1920.04761	–	1932.04761
0,25	1/4"	1912.06351	1920.06351	1925.06351	1932.06351
0,3125	5/16"	1912.07941	1920.07941	1925.07941	1932.07941
0,375	3/8"	1912.09521	1920.09521	1925.09521	1932.09521
0,4375	7/16"	–	1920.11111	1925.11111	1932.11111
0,5	1/2"	–	1920.12701	1925.12701	1932.12701
0,5625	9/16"	–	1920.14291	1925.14291	1932.14291
0,625	5/8"	–	1920.15881	1925.15881	1932.15881
0,6875	11/16"	–	–	–	1932.17461
0,75	3/4"	–	–	1925.19051	1932.19051
0,8125	13/16"	–	–	–	1932.20631
0,875	7/8"	–	–	–	1932.22221
0,9375	15/16"	–	–	–	1932.23811
1,0	1"	–	–	–	1932.25401

## Expert advice

The outer diameter of the reduction sleeves corresponds to each type, e.g. HS 12 equals diameter 12 mm.

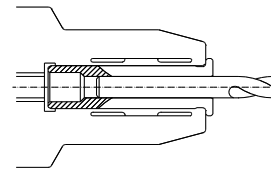

Drawing 1 HSK-A/WD-CB

Ø bore		Part no.			
[decimal inch]	[inch]	HS 1/2"	HS 3/4"	HS 1"	HS 1 1/4"
0,125	1/8"	1913.03182	1919.03182	1926.03182	–
0,1875	3/16"	1913.04762	1919.04762	1926.04762	1931.04762
0,25	1/4"	1913.06352	1919.06352	–	1931.06352
0,3125	5/16"	1913.07942	1919.07942	1926.07942	1931.07942
0,375	3/8"	1913.09522	1919.09522	1926.09522	1931.09522
0,4375	7/16"	–	1919.11112	1926.11112	1931.11112
0,5	1/2"	–	1919.12702	1926.12702	1931.12702
0,5625	9/16"	–	1919.14292	1926.14292	1931.14292
0,625	5/8"	–	1919.15882	–	1931.15882
0,6875	11/16"	–	–	1926.17462	–
0,75	3/4"	–	–	–	1931.19052
0,8125	13/16"	–	–	–	–
0,875	7/8"	–	–	–	–
0,9375	15/16"	–	–	–	–
1,0	1"	–	–	–	1931.25402

## Expert advice

Our chip cover is ideally suited for the removal of chips. The cover can simply be clicked-in at the head of our reduction sleeves.

*For part numbers and more information, please refer to page 29.*

## Expert advice

The coolant flush reductions sleeves HS-CF can be used for peripheral cooling due to their coolant channels.

Easy removing of the reduction sleeve from hydro chucks thanks to the extractor EHS.

*For part numbers and more information, please refer to page 29.*

# Extractors for reduction sleeves EHS

## Chip covers for reduction sleeves CC CC-HS

EHS

CC-HS

Type	Part no.	OAW [mm]	OAL [mm]
<b>Extractors for reduction sleeves EHS</b>			
EHS 12   1/2"	7321.12000	24	100
EHS 20   3/4"	7321.20000	38	160
EHS 25   1"	7321.25000	51	180
EHS 32   1 1/4"	7321.32000	63	200

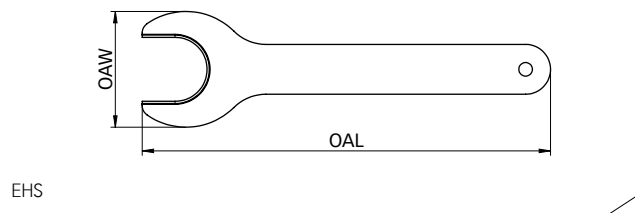

EHS

Type	Part no.	Fits	Reduction sleeve Ø	
			[mm]	[inch]
<b>Chip covers for reduction sleeves CC-HS 12</b>				
CC-HS 12   1/2" / Ø 4.0 mm	7331.04200	HS 12, HS 1/2"	3-4	1/8"
CC-HS 12   1/2" / Ø 6.0 mm	7331.06600	HS 12, HS 1/2"	5-6	3/16"-1/4"
CC-HS 12   1/2" / Ø 10.0 mm	7331.10200	HS 12, HS 1/2"	7-10	5/16"-3/8"

<b>Chip covers for reduction sleeves CC-HS 20</b>				
CC-HS 20   3/4" / Ø 4.0 mm	7333.04200	HS 20, HS 3/4"	3-4	1/8"
CC-HS 20   3/4" / Ø 6.0 mm	7333.06600	HS 20, HS 3/4"	5-6	1/16"-1/4"
CC-HS 20   3/4" / Ø 10.0 mm	7333.10200	HS 20, HS 3/4"	7-10	5/16"-3/8"
CC-HS 20   3/4" / Ø 14.0 mm	7333.14200	HS 20, HS 3/4"	11-14	7/16"-1/2"
CC-HS 20   3/4" / Ø 16.0 mm	7333.16200	HS 20, HS 3/4"	15-16	9/16"-5/8"
CC-HS 20   3/4" / Ø 18.0 mm	7333.18200	HS 20, HS 3/4"	18	-

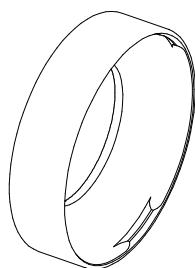

CC-HS

# Get in touch

We love to talk to you and share our toolholding expertise to maximize your productivity.



---

REGO-FIX AG is ISO certified:  
ISO 9001 for quality management / since 1996  
ISO 14001 for environmental management / since 2007  
ISO 45001 for occupational health and safety / since 2019

---

This document should not be used or relied on for any purpose other than that intended by REGO-FIX AG.  
No part of this document may be reproduced or transmitted in any other form without the express written permission of REGO-FIX AG.

---

The data given in this catalog are dependent on the conditions under which they are measured and are derived from tests carried out under defined lab conditions at REGO-FIX AG. The performance of these tools depends on the conditions under which they are used and may vary from case to case. The information given in this catalog is believed to be correct. REGO-FIX AG however assumes no responsibility or liability for any errors, inaccuracies or omissions that may appear in this catalog. Information in this catalog is subject to change without notice and should not be construed as a commitment by REGO-FIX AG or its subsidiaries. This is especially valid for adaptations to new or changed international standards or improvements to the products performance or production processes.

---

Softsynchro® is a registered trademark of EMUGE-Werk Richard Glimpel GmbH & Co. KG. Viton® is a brand of synthetic rubber and fluoropolymer elastomer of DuPont Performance Elastomers. Capto® is a registered trademark of AB Sandvik Coromant. BIG PLUS® is licensed by BIG Daishowa.

---



**Swiss quality standard**

Our products marked Swiss made are manufactured at our headquarters in Tenniken, Switzerland.

