



EWS . Varia VX

Redução do tempo de presetting com powRgrip® e o sistema inovador EWS Varia VX de troca rápida

Reduction of set-up time through powRgrip® and the EWS Varia VX quick change system

Adaptador Varia VX para powRgrip®

Varia VX-Adapter for powRgrip®

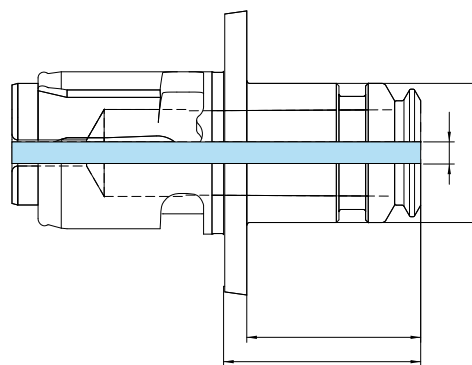

Tipo/ Type	Nr. da Peça/Part no.	Dimensões/Dimensions [mm]				
		D1	d min.	d max.	L	L1
Adaptador powRgrip® Varia VX						
EWS VX3 / PG 15	8350.03150 19.VX3PG15L29.5*	24	3	12.7	34	30
EWS VX4 / PG 25**	8350.04251 19.VX4PG25L39*	40	3	20	45	41











*EWS Nr. da Peça/Part no.

**Só pode ser fixada com PGU/Only to be used with PGU

Tipos de pinça powRgrip®

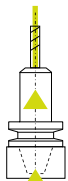
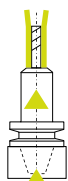
powRgrip® collet types

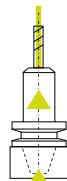
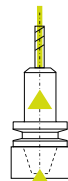

							
	Std.	CF	CB	L	S	SG	TAP
	Standard	CoolFlush	CoolBore	Long	Short	secuRgrip®	Tapping
Aplicação Application	Geral General	Leve – Média Easy – Medium	Média – Pesada Medium – Heavy	Compr. > DIN 6535 Length > DIN 6535	Compr. < DIN 6535 Length < DIN 6535	Pesada Heavy	Rosqueamento Tapping
PG-Taman./PG-Size	15–25	15–25	15–25	15–25	15–25	15–25	15–25
Ø	3–20	3–20	6–20	4–20	4–20	10–20	3.5–16
Tolerância de haste Shank Tolerance	h6	h6	h6	h6	h6	h6	h9
Características Features	Presetting de compr. Length presetting	Presetting de compr. Length presetting	Presetting de compr. Length presetting	Sem preset de compr. No length presetting	Presetting de compr. Length presetting	Para hastes Weldon For Weldon shanks	Presetting de compr. Length presetting
Resfriamento (periférico ou interno) Coolant (peripheral or internal)							

REGO-FIX powRgrip®

SIMPLES / SIMPLE

Ferramenta é prensada em 8 segundos ao apertar de um botão.

Tool is clamped in 8 seconds by pushing one single button.

SEGURO / SAFE

Sem calor – Alta força de aperto.

No heat – high clamping force.

powRgrip®

O sistema de fixação de ferramentas de hoje e de amanhã.

The tool clamping system of today and tomorrow.



Ferramenta de corte
Cutting tool



Pinça REGO-FIX powRgrip®
REGO-FIX powRgrip® collet



Adaptador Varia VX para powRgrip®
Varia VX-adapter for powRgrip®

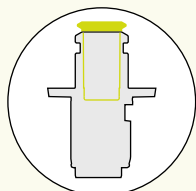

Excelente concentricidade com alta repetibilidade.
Excellent concentricity with high repeatability.

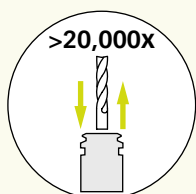

Máxima força de aperto e baixo batimento mesmo após 20'000 trocas de ferramenta.
Maximum clamping force and low runout, even after 20,000 tool changes.

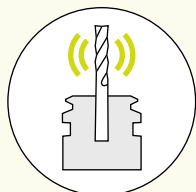

Excelente amortecimento de vibrações.
Excellent vibration dampening.

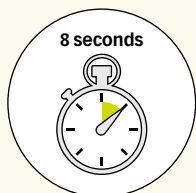

Ferramenta pronta para uso em 8 segundos com a PGU 9500.
Tool ready for use in 8 seconds.





REGO-FIX AG

Obermattweg 60 / 4456 Tenniken / Suiça

www.rego-fix.com