



EWS . Varia VX

Rüstzeitreduzierung durch powRgrip® und das innovative EWS Varia VX Schnellwechselsystem

Reduction of set-up time through powRgrip® and the EWS Varia VX quick change system

Varia VX-Adapter für powRgrip®

Varia VX-Adapter for powRgrip®

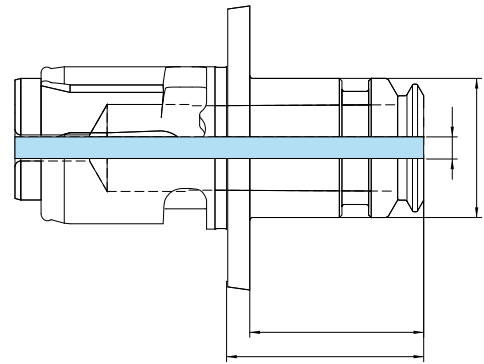

Typ/ Type	Art.-Nr./Part no.	Abmessungen/Dimensions [mm]				
		D1	d min.	d max.	L	L1
powRgrip® Varia VX-Adapter						
EWS VX3/ PG 15	8350.03150 19.VX3PG15L29.5*	24	3	12.7	34	30
EWS VX4/ PG 25**	8350.04251 19.VX4PG25L39*	40	3	20	45	41









*EWS Art.-Nr./Part no.

**Nur spannbar mit PGU/Only to be used with PGU

powRgrip® Spannzangen Typ

powRgrip® collet types

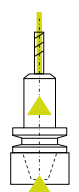
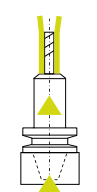
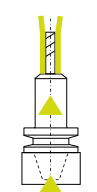
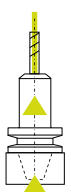

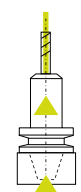
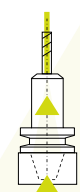
							
	Std.	CF	CB	L	S	SG	TAP
	Standard	CoolFlush	CoolBore	Long	Short	secuRgrip®	Tapping
Anwendung Application	Allgemein General	Leicht – Mittel Easy – Medium	Mittel – Schwer Medium – Heavy	Länge > DIN 6535 Length > DIN 6535	Länge < DIN 6535 Length < DIN 6535	Schwer Heavy	Gewinde- bohren Tapping
PG-Grösse/PG-Size	15–25	15–25	15–25	15–25	15–25	15–25	15–25
Ø	3–20	3–20	6–20	4–20	4–20	10–20	3.5–16
Schafttoleranz Shank Tolerance	h6	h6	h6	h6	h6	h6	h9
Eigenschaften Features	Längenvor- einstellung Length presetting	Längenvor- einstellung Length presetting	Längenvor- einstellung Length presetting	keine Vor- einstellung No length presetting	Längenvor- einstellung Length presetting	Für Weldon- Schäfte For Weldon shanks	Längenvor- einstellung Length presetting
Kühlung (periphere oder Innenkühlung) Coolant (peripheral or internal)							

REGO-FIX powRgrip®

EINFACH / SIMPLE

Werkzeug per Knopfdruck in 8 Sekunden gespannt.
Tool is clamped in 8 seconds by pushing one single button.

SICHER / SAFE

Keine Hitzeentwicklung – hohe Spannkraft.
No heat – high clamping force.

powRgrip®

Das Werkzeugspannsystem für heute und morgen.
The tool clamping system of today and tomorrow.



Schneidwerkzeug
Cutting tool



REGO-FIX powRgrip® Spannzange
REGO-FIX powRgrip® collet



Varia VX-Adapter für powRgrip®
Varia VX-adapter for powRgrip®

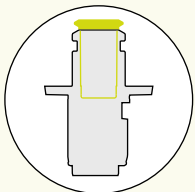

Ausgezeichneter Rundlauf bei hoher Wiederholbarkeit.
Excellent concentricity with high repeatability.

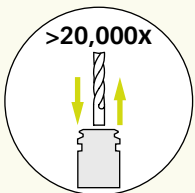

Höchste Haltekraft und Rundlaufgenauigkeit auch nach 20'000-fachem Werkzeugwechsel.
Maximum clamping force and low runout, even after 20,000 tool changes.

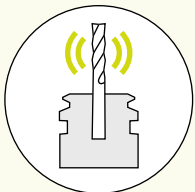

Hervorragende Vibrationsdämpfung.
Excellent vibration dampening.

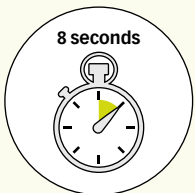

Einsatzbereite Werkzeuge in 8 Sekunden mit der PGU 9500.
Tool ready for use in 8 seconds.





REGO-FIX AG

Obermattweg 60 / 4456 Tenniken / Schweiz

www.rego-fix.com